

# Modelo GA7063R 180MM ANGLE GRINDER

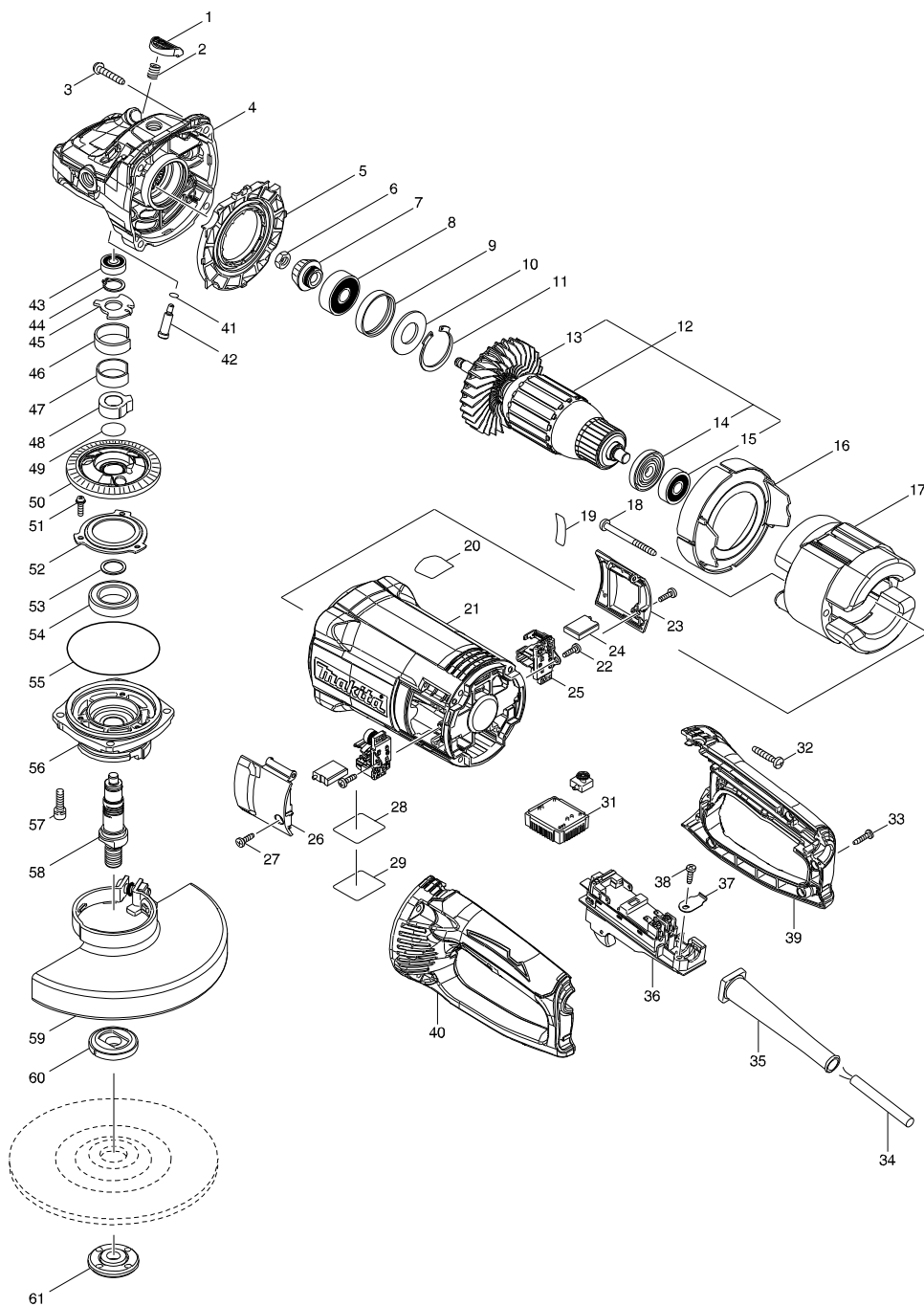

## Modelo GA7063R 180MM ANGLE GRINDER

Página 1 / 2

Pieza	Código	Descripción	Info	CTD.	N/O	Opc. 1	Opc. 2	OBS.
001	456247-8	PIN CAP		1				
002	234391-9	COMPRESSION SPRING 8		1				
003	251489-7	TAPPING SCREW 5X30		4				
004	143485-8	GEAR HOUSING COMPLETE		1				
C10	263002-9	RUBBER PIN 4		1				
005	456238-9	DIFFUSER		1				
006	252194-9	HEX. NUT M8		1				
007	227655-8	SPIRAL BEVEL GEAR 17		1				
008	211132-0	BALL BEARING 6301DDW		1				
009	262085-6	RUBBER RING 38		1				
010	267299-2	FLAT WASHER 20		1				
011	962211-4	RETAINING RING R-42		1				
D10		INC. 13-15						
012A	513447-4	ARMATURE ASS'Y 115V		1				
012B	513448-2	ARMATURE ASS'Y 220V		1				
013	240161-6	FAN 86		1				
014	681630-2	INSULATION WASHER		1				
015	211087-9	BALL BEARING 6200DDW		1				
016	456239-7	BAFFLE PLATE		1				
017A	621777-0	FIELD 115V		1				
017B	621778-8	FIELD 220V		1				
018	266044-2	TAPPING SCREW 5X60		2				
019	853D07-7	GA7063R SERIAL NO. LABEL		1				
020	898443-6	SJS2 MARK LABEL		1				
021	144525-5	MOTOR HOUSING COMPLETE		1				
C10	812K33-7	CAUTION LABEL		1				
022	266385-6	TAPPING SCREW 4X14		2				
023	456246-0	BRUSH HOLDER COVER R		1				
024	197128-4	CARBON BRUSH CB-218		1				
025	643715-2	BRUSH HOLDER		2				
026	456245-2	BRUSH HOLDER COVER L		1				
027	266385-6	TAPPING SCREW 4X14		2				
028	853D05-1	GA7063R NAME PLATE		1				
029	808D02-2	CLEAR LABEL		1				
031A	620469-8	CONTROLLER		1				
031B	620470-3	CONTROLLER		1				
032	251489-7	TAPPING SCREW 5X30		4				
033	266326-2	TAPPING SCREW 4X18		4				
034A	664463-0	POWER SUPPLY CORD AWG#14-2-2.8		1				
034B	691216-4	POWER SUPPLY CORD 1.25-2-2.5		1				
035	682573-1	CORD GUARD 10		1				
036	632F77-9	SWITCH UNIT		1				
037A	687169-3	STRAIN RELIEF		1				
037B	687678-2	STRAIN RELIEF		1				
038	266385-6	TAPPING SCREW 4X14		1				
039	183G25-2	HANDLE SET		1				
D10		INC. 40						
040	183G25-2	HANDLE SET		1				

**Modelo GA7063R 180MM ANGLE GRINDER**

Pieza	Código	Descripción	Info	CTD.	N/O	Opc. 1	Opc. 2	OBS.
D10		INC. 39						
041	213026-5	O RING 7		1				
042	256571-7	SHOULDER PIN 7		1				
043	211032-4	BALL BEARING 608ZZ		1				
044	961055-9	RETAINING RING S-15		1				
045	346980-9	BALANCER		1				
046	346981-7	C TYPE PLATE 33		1				
047	346982-5	C TYPE PLATE 29		1				
048	326640-9	JOINT SLEEVE		1				
049	213859-8	O-RING 19		1				
050	227657-4	SPIRAL BEVEL GEAR 55		1				
051	911128-8	P.H.SCREW M4X16 WITH WR		3				
052	285742-9	BEARING RETAINER 59		1				
053	253725-7	FLAT WASHER 17		1				
054	211377-0	BALL BEARING 6905LLB		1				
055	213760-7	O RING 78		1				
056	143515-5	BEARING BOX COMPLETE		1				
057	265541-5	HEX. SOCKET HEAD BOLT M6X22		4				
058	326642-5	SPINDLE A		1				
059	122939-8	WHEEL COVER 180AK ASSEMBLY		1				
C10	213017-6	O RING 6		1				
C20	265198-2	+PAN HEAD SCREW M8X25		1				
060	224378-9	INNER FLANGE 45		1				
061	224486-6	LOCK NUT 5/8-45		1				
A01	143486-6	GRIP 37 COMPLETE		1				
A02	782412-6	LOCK NUT WRENCH 28		1				