

Modelo GB600 ESMERIL DE BANCO

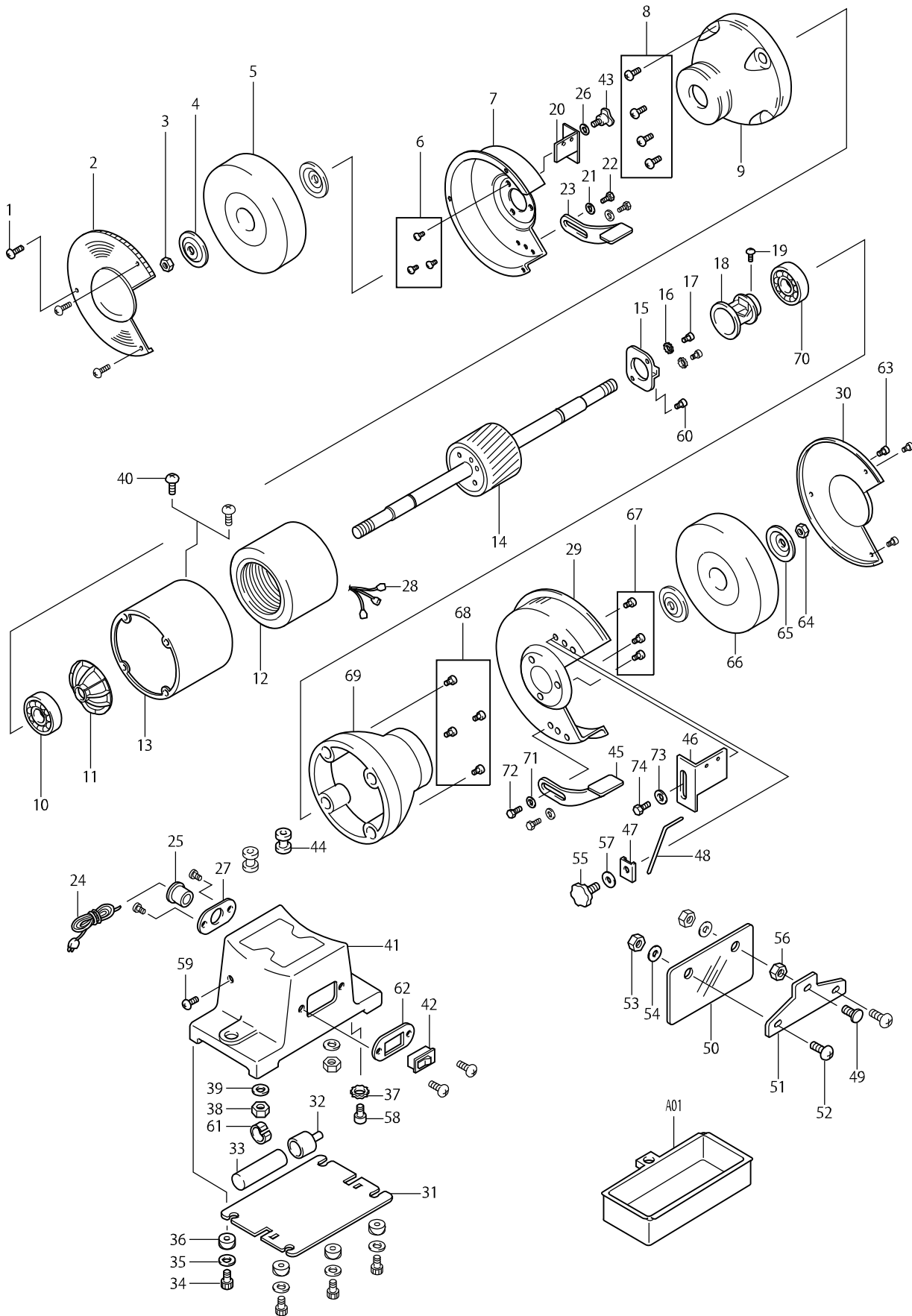

Pieza	Código	Descripción	Info	CTD.	N/O	Opc. 1	Opc. 2	OBS.
001	6001	SCREW		3				
002	6002	COVER		1				
	D10	INC. 30						
003	6003	TUERCA P/GB601		1				
004	6004	FLANGE		2				
005	6005	GRINDER WHEEL		1				
006	6006	SCREW		3				
007	6007	WHEEL GUARD		1				
	D10	INC. 29						
008	6008	SCREW		4				
009	6009	CAMPANA Y MOTOR P/GB601		1				
010	6010	BALL BEARING		1				
011	6011	VENTILADOR P/GB601		1				
012	6012	CAMPO P/GB601		1				
013	6013	CAJA DEL MOTOR P/GB601		1				
014	6014	ARMADURA P/GB601		1				
	D10	INC. 11						
015	6015	HOJA DE ENCENDIDO CENTRIFUGO,		1				
016	6016	STAR WASHER		2	*			
017	6017	SCREW		2				
018	6018	INTERRUPTOR DE ENCENDIDO CENT		1				
019	6019	SCREW		1				
020	6020	SPARK BREAKERS		1				
021	6021	WASHER		2				
022	6022	BOLT		2				
023	6023	DESCANSO AJUSTABLE IZQUIERDO,		1				
024	6024	WIRE		1				
025	6025	STRAIN RELIEF		1				
026	6026	WASHER		1				
027	6027	BASE P/GB601		1				
	C10	6006	SCREW	2	*			
	C11	6001	SCREW	X	2			
028	6028	TERMINALS		5				
029	6029	WHEEL GUARD		1				
	D10	INC. 7						
030	6030	COVER		1				
	D10	INC. 2						
031	6031	BASE P/GB601		1				
032	6032	CUBIERTA DEL CAPACITOR, GB601		1				
033	6033	CAPACITOR P/GB601		1				
034	6034	SCREW		4				
035	6035	WASHER		4				
036	6036	RESPALDO DE LA BASE, GB601		4				
037	6037	STAR WASHER		1	*			
038	6038	NUT		2				
039	6039	LOCK WASHER		2				
040	6040	SCREW		2				
041	6041	BASE P/GB601		1				

