

Model No.CE004G 305MM CORDLESS POWER CUTTER

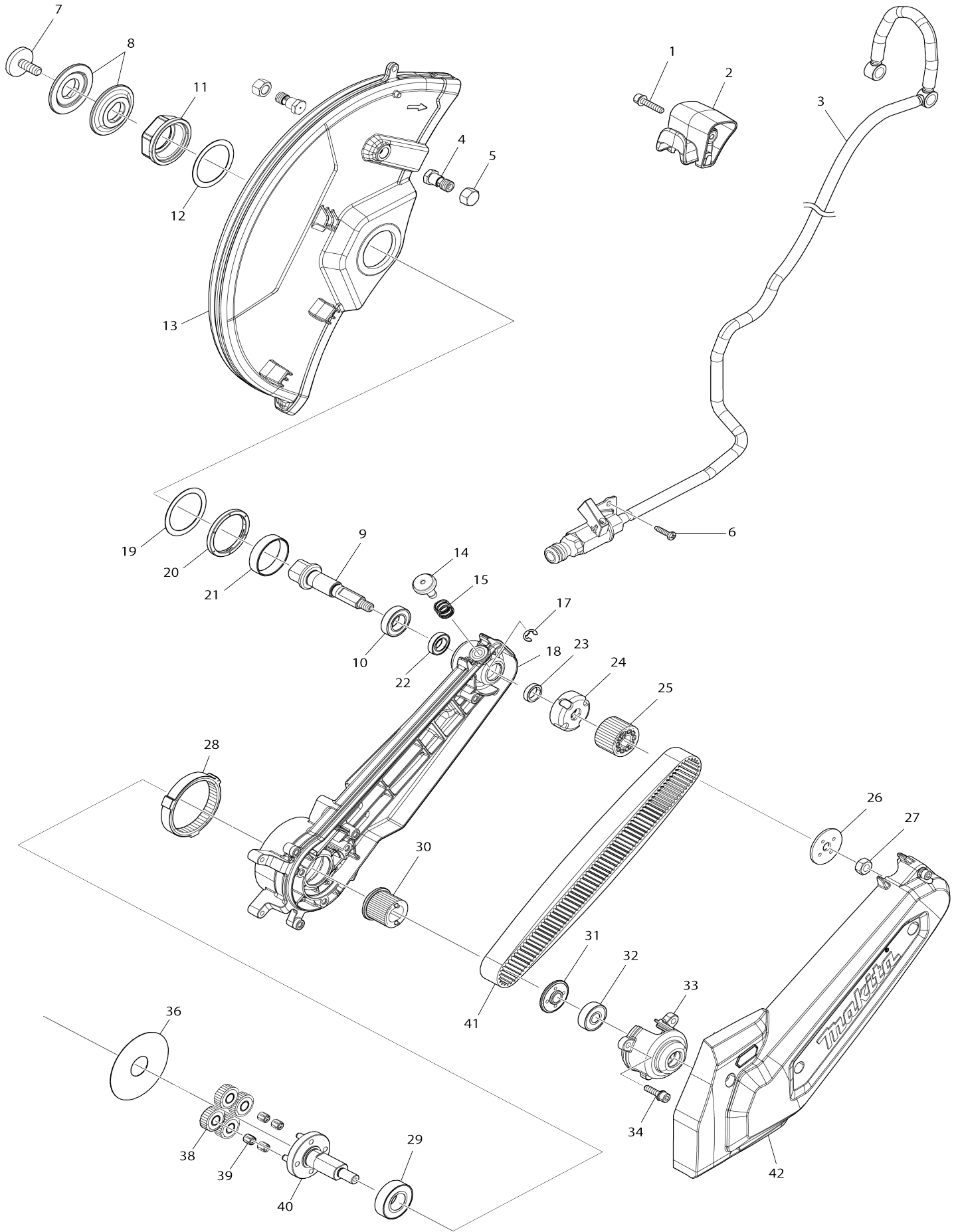

Model No.CE004G 305MM CORDLESS POWER CUTTER

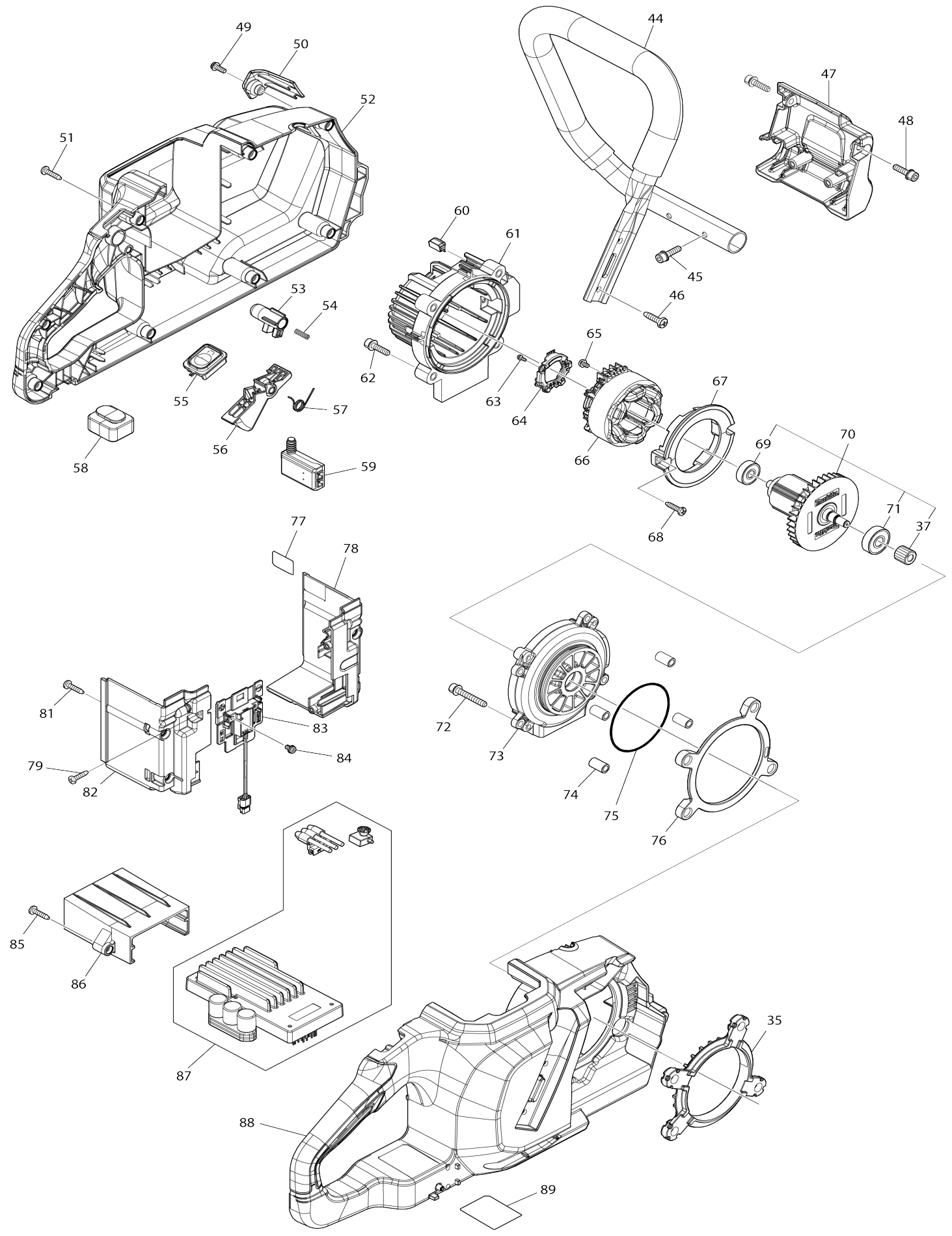

044	327D37-9	FRONT GRIP 26		1		
045	922233-6	Perno de cabeza hueca hexagonal M5X20 WR		2		
046	266420-0	Tornillo enroscante con cabezal fijador 5X20		2		
047	312F04-9	STAND SUPPORT		1		
048	922233-6	Perno de cabeza hueca hexagonal M5X20 WR		2		
049	911118-1	Tornillo de cabeza aplanada M4X12 WR		1		
050	413Y18-6	LENS		1		
051	266326-2	Tornillo enroscante con cabezal fijador 4X18		8		
052	1830N5-4	HOUSING SET		1		
052		INC. 88				
053	413Y21-7	LOCK OFF BUTTON		1		
054	232444-8	Resorte de compresión 4		1		
055	141V21-6	SWITCH CIRCUIT COMPLETE		1		
056	413Y20-9	SWITCH LEVER		1		
057	232854-9	TORSION SPRING 10		1		
058	422823-0	Pata		1		
059	632V44-0	SWITCH UNIT		1		
060	620N97-3	LED CIRCUIT		1		
061	413Y19-4	MOTOR HOUSING		1		
062	922233-6	Perno de cabeza hueca hexagonal M5X20 WR		4		
063	652119-7	Tornillo de cabeza aplanada M2X6		3		
064	620P38-1	SENSOR UNIT		1		
065	652069-6	Tornillo de cabeza plana M3X6		3		
066	629C70-4	STATOR		1		
067	413Y22-5	BAFFLE PLATE		1		
068	266326-2	Tornillo enroscante con cabezal fijador 4X18		2		
069	210023-2	Rodamiento de balines 627DDW		1		
070	519856-5	ROTOR ASS'Y		1		
070		INC. 37,69,71				
071	211092-6	Rodamiento de balines 629DDW		1		
072	922258-0	Perno de cabeza hueca hexagonal M5X35 WR		4		
073	312F00-7	BEARING BOX		1		
074	257A33-4	SLEEVE 6		4		
075	213720-9	Anillo o-ring 67		1		
076	422B45-4	DAMPAR B		1		
077	8146N9-8	CE004G SERIAL NO.LABEL		1		
078	1830M9-9	TERMINAL BOX SET		1		
C10	263005-3	Pasador de goma 6		2		
078		INC. 82				
079	266326-2	Tornillo enroscante con cabezal fijador 4X18		2		
081	266326-2	Tornillo enroscante con cabezal fijador 4X18		4		
082	1830M9-9	TERMINAL BOX SET		1		
C10	263005-3	Pasador de goma 6		2		
082		INC. 78				

083	632V23-8	TERMINAL UNIT		1		
084	652031-1	Tornillo de cabeza aplanada M3X 6		2		
085	266326-2	Tornillo enroscante con cabezal fijador 4X18		2		
086	413Y25-9	CONTROLLER CASE		1		
087	620N99-9	CONTROLLER		1	*	
087-1	620N99-9	CONTROLLER	O	1		
088	1830N5-4	HOUSING SET		1		
088		INC. 52				
089	8146N8-0	CE004G NAME PLATE		1		
A01	122G62-1	WRENCH HOLDER ASSEMBLY		1		
A02	123120-4	Manguito de registro		1		
A03	782039-2	BOX WRENCH 13-19		1		
A04	1914A3-7	RING SET		1		
A05	224636-3	FLANGE 80		2		

Por favor declare No. de Partes cuando ordene.

Fecha de Impresión 21/01/2025